

GSPRINT4521

Evaluation Kit

General Description

Gpixel's evaluation platform supports CoaXPress 2.0 or USB3 Interface, is ideal for an easy and accurate evaluation of the GSPRINT4521 CMOS sensor. Its form factor, the GenICam compatibility and external triggering options provide flexible setup options in both lab and industrial environments. The high-speed CoaXPress /USB3 interface ensures a smooth, real-time imaging experience.

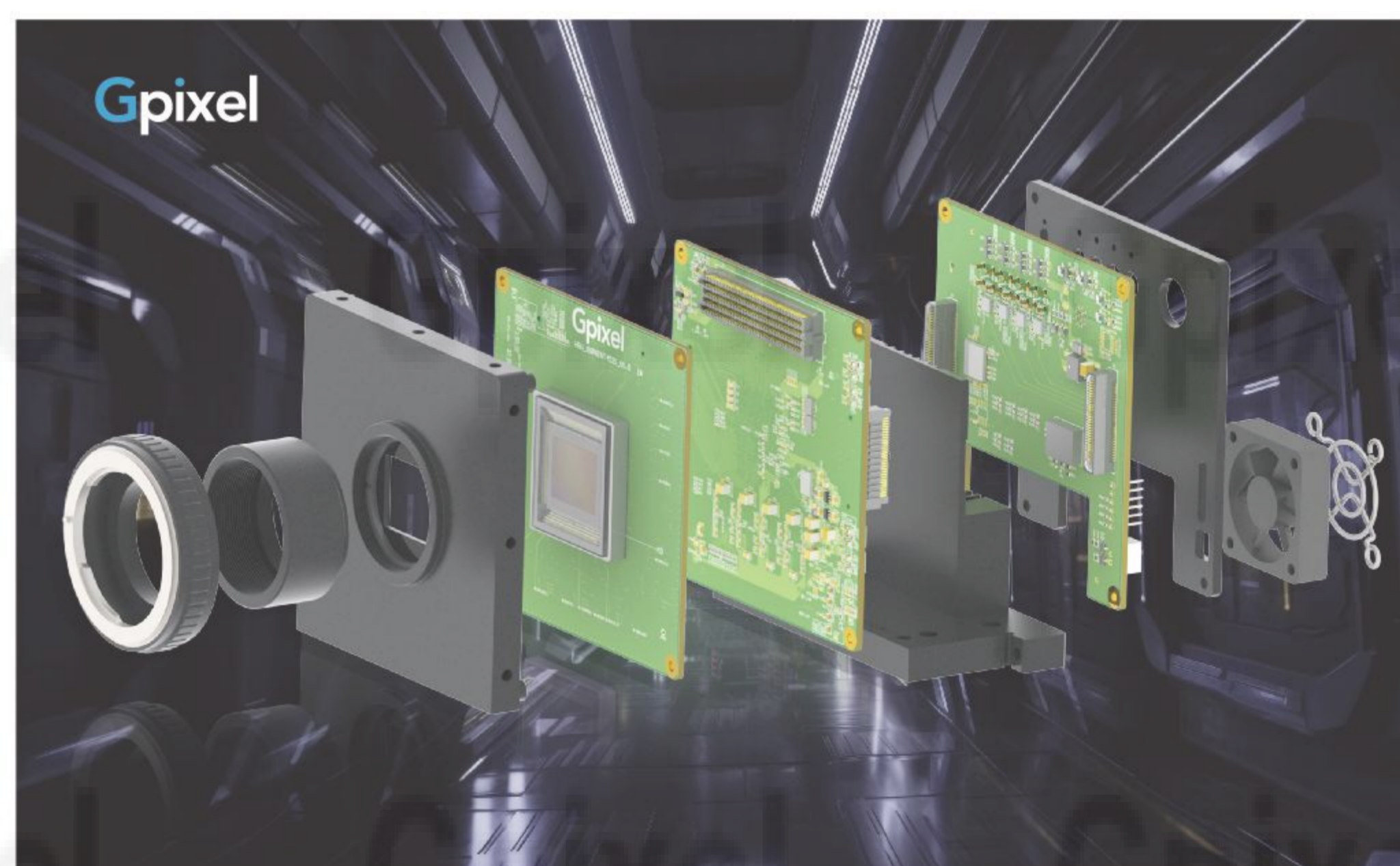
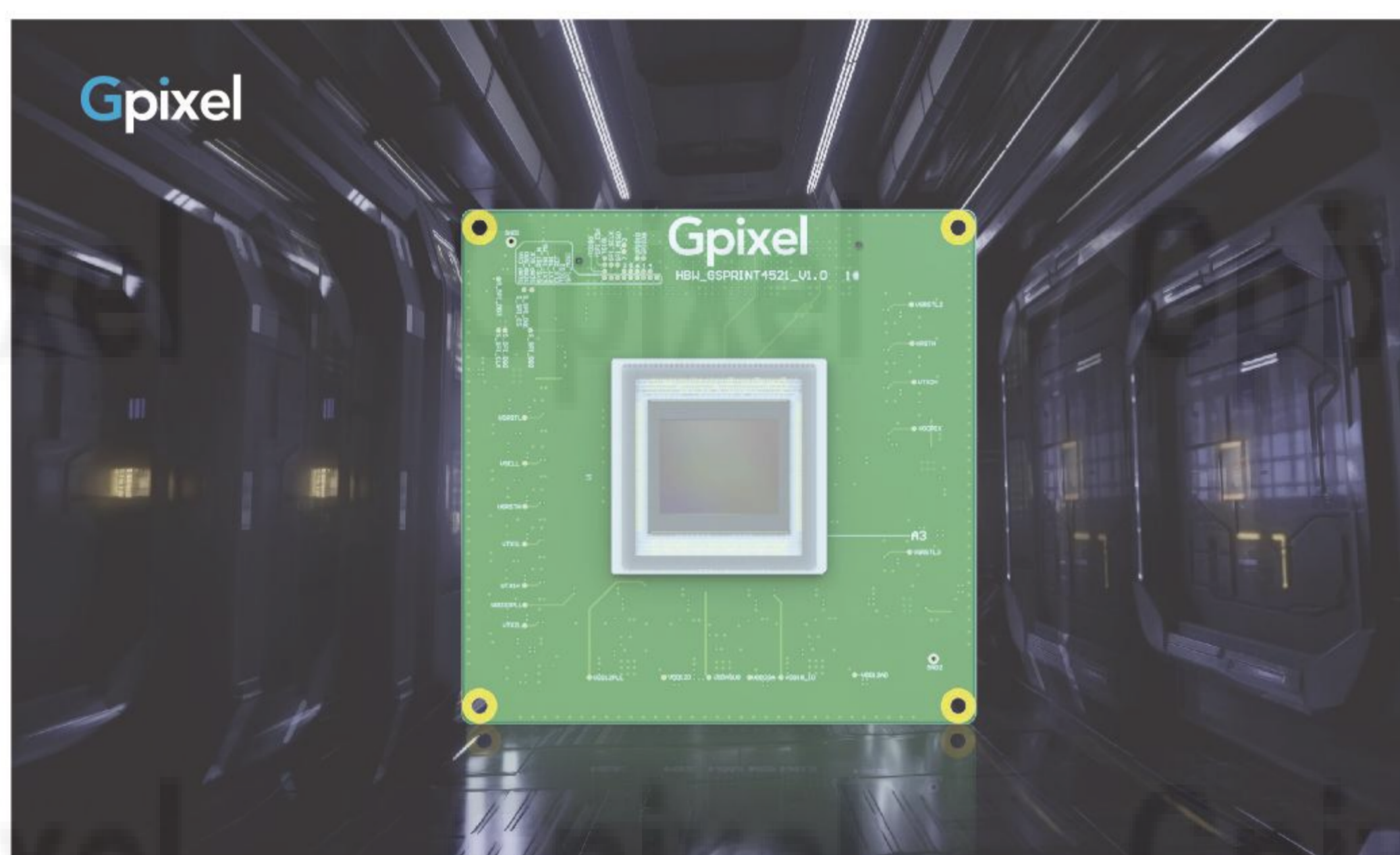

Key Features

- CoaXPress 2.0 Interface/USB3 Interface
- Raw Image Output
- 8/10/12-bit Modes
- Normal, Binned or Windowed Readout
- GenICam Compatible
- User-friendly Form Factor
- M42- and F-mount

Specifications

Item	Description
Sensor	GSPRINT4521
Output Interface	CoaXPress 2.0/USB3
Resolution (H x V)	5120 x 4096
Frame Rates	Normal: 187fps (8b) / 125fps (12b)@ CoaXPress 2.0 18fps (8b) / 9fps (12b)@ USB3 Binned: 715fps (8b) / 465fps (12b) @ CoaXPress 2.0 72fps (8b) / 36fps (12b)@ USB3
Exposure Time	4s ~ 49.99s
Pixel Bit Depth	8/10/12-bit
Trigger Mode	External / Free Running
Lens Mount	M42-mount / F-mount
Power Supply	10 – 25V
Power Consumption	Typical 26.5W@12V DC @CoaXPress 2.0 Typical 15.6W@12V DC @USB3
Operating Temperature	0-50°C

Ordering Information

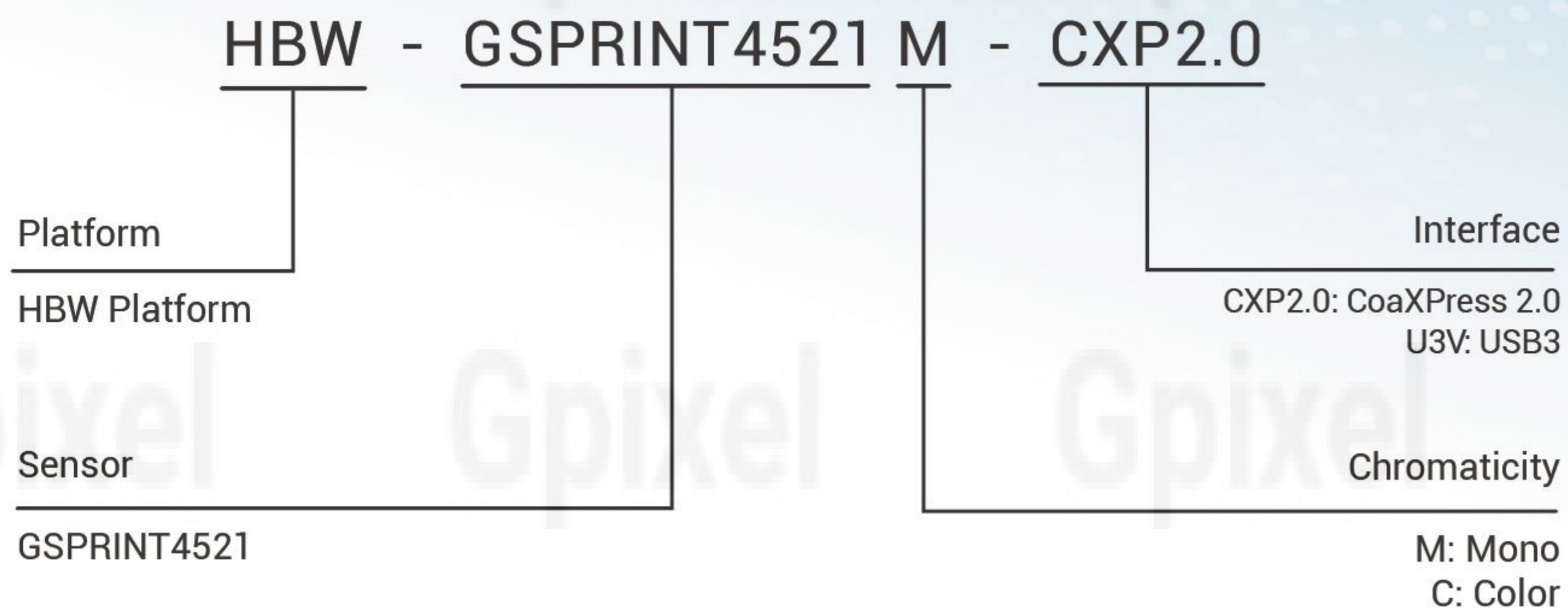

Note: Sensor is soldered on the PCB

Evaluation Kit Includes

- Evaluation module
- Power adapter
- Power Cable with DC plug and trigger
- DC Plug adapter 2.1mm to 2.5mm
- Extension ring M42 to M42
- F-mount adapter
- USB Cable Type-A to Micro-B (only USB3 Interface)

Note: a CXP2.0 frame grabber and four CXP cables are required to use this evaluation kit.

Mechanical Drawing

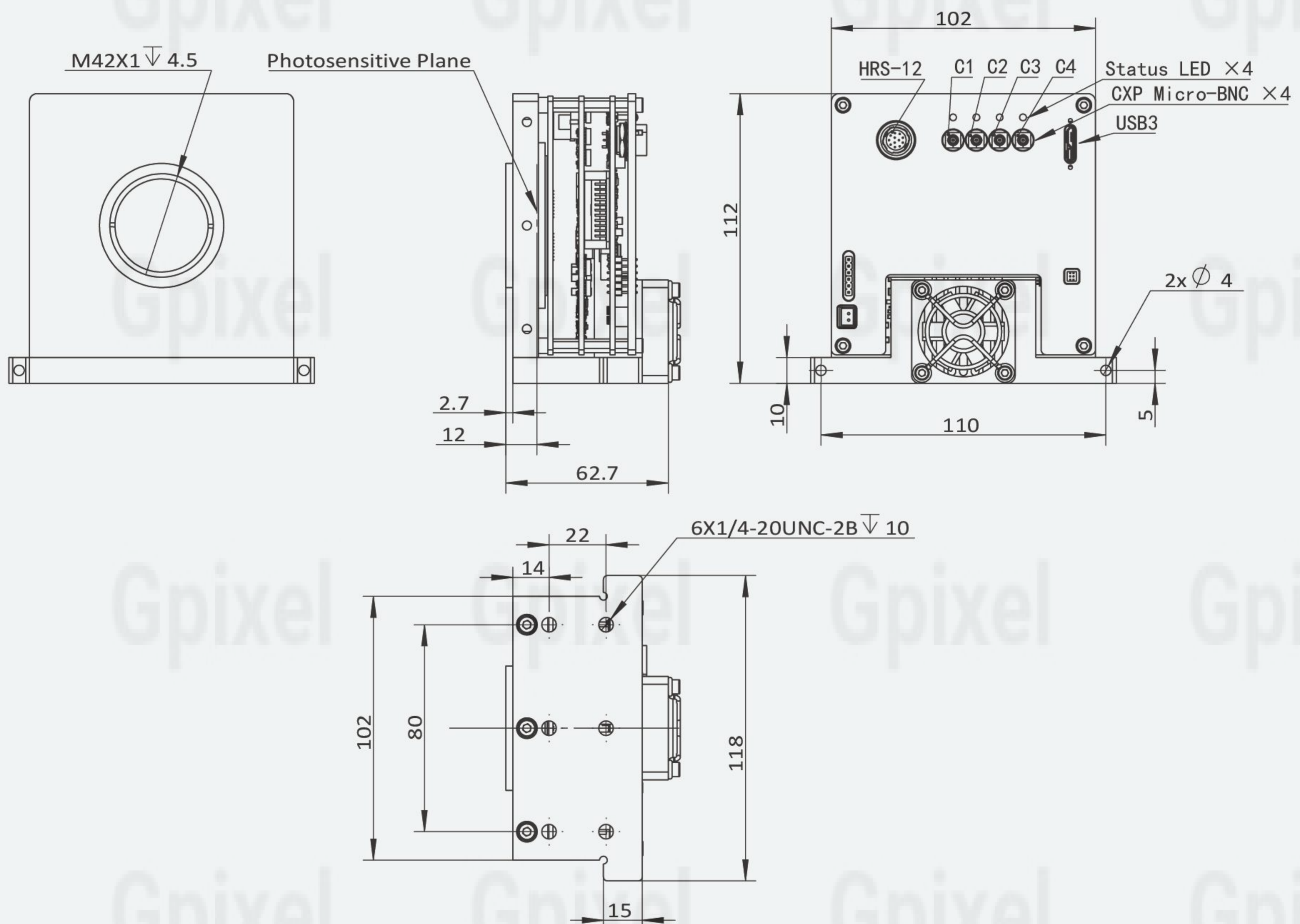

Note: HBW-GSPRINT4521M-CXP2.0 only has CXP Micro-BNC connector,
HBW- GSPRINT4521M-U3V only has USB3 Micro-B connector.

Contact Gpixel HQ

Add: Building #5, Optoelectronic Information Industrial Park, #7691 Ziyou Road,
Changchun, Jilin, China.

Tel: +86-0431-85077785

Email: info@gpixel.com

Website: www.gpixel.com

Revision 20240222

